

HÆGER

MOUNTING INSTRUCTIONS INSTRUCCIONES DE MONTAJE INSTRUÇÕES DE MONTAGEM INSTRUZIONI DI MONTAGGIO



Model: WB-T32.023A

VESA 75/100

 20kg(44 lbs) max.

 13" - 32"(33-81cm)

HAEGERTEC, S.A.
Praceta Cidade de Londres, 1
Parque Industrial do Arneiro
2660-456 S.Julião do Tojal - PORTUGAL
Tel. +351 219498300

▶ WARNING STATEMENTS

Warning

The wall structure must be capable of supporting at least a maximum weight of 20kg (44lbs) for 13"-32" televisions. If not, the wall must be reinforced. Proper installation procedure by a qualified service technician, as outlined in the installation instructions, must be adhered to. Failure to do so could result in serious personal injury, or even death.

Safety measures must be practiced at all times during the installation of this product. Use proper safety gear and tools for the installation procedure to prevent personal injury.

Prior to the installation of this product, the installation instructions should be read and completely understood. The installation instructions must be read to prevent personal injury and property damage. Keep these installation instructions in an easily accessible location for future reference.

 A secure structure must support the weight or load of the display. When mounting to a wall that contains wooden studs, dead center of the wooden stud must be confirmed prior to installation.

 Do not install on a structure that is prone to vibration, movement or chance of impact. Failure to do so could result in damage to the display and/or damage to the mounting surface.

 Do not install near heater, fireplace, direct sunlight, air conditioning or any other source of direct heat energy. Failure to do so may result in damage to the display and could increase the risk of fire.

 At least two qualified people should perform the installation procedure. Injury and/or damage can result from dropping or mishandling the display.

 Recommended mounting surfaces: wooden studs and solid-flat concrete. If the mount is to be installed on any surface other than wooden studs, use suitable hardware (which is commercially available).

▶ DECLARACIONES DE ADVERTENCIA

Advertencia

La estructura de la pared debe ser capaz de soportar al menos un peso máximo de 20kg (44lb) para televisores de 13" a 32". Si no, la pared debe ser reforzada. Se debe cumplir con el procedimiento de instalación correcto realizado por un técnico de servicio calificado, como se describe en las instrucciones de instalación. De lo contrario, podría ocasionarse una lesión personal grave o incluso la muerte.

Las medidas de seguridad deben practicarse en todo momento durante la instalación de este producto. Use el equipo de seguridad adecuado y las herramientas para el procedimiento de instalación para evitar lesiones personales.

Antes de la instalación de este producto, las instrucciones de instalación deben leerse y comprenderse por completo. Las instrucciones de instalación deben leerse para evitar lesiones personales y daños a la propiedad. Guarde estas instrucciones de instalación en una ubicación de fácil acceso para referencia futura.

 Una estructura segura debe soportar el peso o la carga de la pantalla. Cuando se monte en una pared que contenga montantes de madera, se debe confirmar el punto muerto del montante de madera antes de la instalación.

 No instale en una estructura propensa a vibraciones, movimiento o posibilidad de impacto. De lo contrario, podría dañar la pantalla y / o dañar la superficie de montaje.

 No instale cerca del calentador, la chimenea, la luz solar directa, el aire acondicionado ni ninguna otra fuente de energía térmica directa. De lo contrario, puede dañar la pantalla y aumentar el riesgo de incendio.

 Al menos dos personas calificadas deben realizar el procedimiento de instalación. Lesiones y / o daños pueden ser el resultado de una caída o mal manejo de la pantalla.

 Superficies de montaje recomendadas: tacos de madera y concreto sólido y plano. Si la montura debe instalarse en cualquier superficie que no sean pernos de madera, use el material adecuado (que esté disponible comercialmente).

▶ DECLARAÇÕES DE ADVERTÊNCIA

Atenção

A estrutura da parede deve ser capaz de suportar pelo menos um peso máximo de 20kg (44lbs) para televisores de 13" - 32". Se não, a parede deve ser reforçada. Deve ser respeitado o procedimento de instalação correcto realizado por um técnico qualificado, conforme descrito nas instruções de instalação. Caso contrário pode resultar em ferimentos graves ou até mesmo morte.

As medidas de segurança devem ser praticadas em todos os momentos durante a instalação deste produto. Use equipamento de segurança e ferramentas adequados para o procedimento de instalação para evitar ferimentos pessoais.

Antes da instalação deste produto, as instruções de instalação devem ser lidas e completamente compreendidas. As instruções de instalação devem ser lidas para evitar ferimentos e danos materiais. Mantenha estas instruções de instalação em um local de fácil acesso para referência futura.

 Uma estrutura segura deve suportar o peso ou a carga do monitor. Ao montar em uma parede que contém pinos de madeira, o centro morto do pino de madeira deve ser confirmado antes da instalação.

 Não instale em uma estrutura propensa a vibração, movimento ou possibilidade de impacto. Caso contrário pode resultar em danos ao monitor e/ou danos à superfície de montagem.

 Não instale perto do aquecedor, lareira, luz solar direta, ar condicionado ou qualquer outra fonte de energia térmica direta. Caso contrário pode resultar em danos ao monitor e aumentar o risco de incêndio.

 Pelo menos duas pessoas qualificadas devem executar o procedimento de instalação. Lesões e/ou danos podem resultar da queda ou manuseio incorreto do monitor.

 Superfícies de montagem recomendadas: pinos de madeira e concreto liso e plano. Se a montagem for instalada em qualquer superfície que não seja de madeira, use material adequado (disponível comercialmente).

▶ DÉCLARATIONS D'AVERTISSEMENT

Attention

La structure murale doit être capable de supporter au moins un poids maximum de 20 kg (44 lb) pour les téléviseurs de 13 à 32 pouces. Sinon, le mur doit être renforcé. La procédure d'installation appropriée par un technicien de service qualifié, comme indiqué dans les instructions d'installation, doit être respectée. Le non-respect de cette consigne peut entraîner des blessures graves ou même la mort.

Des mesures de sécurité doivent être appliquées à tout moment pendant l'installation de ce produit. Utilisez un équipement et des outils de sécurité appropriés pour la procédure d'installation afin d'éviter les blessures.

Avant l'installation de ce produit, les instructions d'installation doivent être lues et entièrement comprises. Les instructions d'installation doivent être lues pour éviter les blessures et les dommages matériels. Conservez ces instructions d'installation dans un endroit facilement accessible pour référence future.

 Une structure sécurisée doit supporter le poids ou la charge de l'écran. Lors du montage sur un mur contenant des montants en bois, le point mort du montant en bois doit être confirmé avant l'installation.

 Ne pas installer sur une structure sujette aux vibrations, aux mouvements ou aux chocs. Le non-respect de cette consigne pourrait endommager l'écran et / ou endommager la surface de montage.

 Ne pas installer près d'un radiateur, d'un foyer, de la lumière directe du soleil, de la climatisation ou de toute autre source d'énergie thermique directe. Le non-respect de cette consigne peut endommager l'écran et augmenter le risque d'incendie.

 Au moins deux personnes qualifiées doivent effectuer la procédure d'installation. Des blessures et / ou des dommages peuvent résulter d'une chute ou d'une mauvaise manipulation de l'écran.

 Surfaces de montage recommandées: montants en bois et béton plat solide. Si le support doit être installé sur une surface autre que des montants en bois, utilisez du matériel approprié (disponible dans le commerce).

► **TOOLS REQUIRED NOT INCLUDED**
HERRAMIENTAS REQUERIDAS (NO INCLUIDAS)
FERRAMENTAS NECESSÁRIAS (NÃO INCLUIDAS)
OUTILS REQUIS NON INCLUS

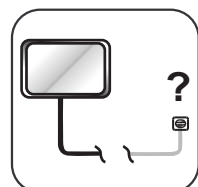
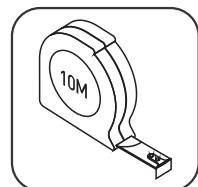
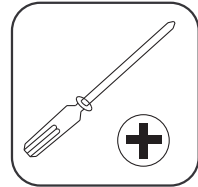
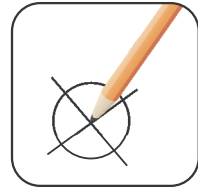

► **PARTS INCLUDED**
PIEZAS INCLUIDAS
PEÇAS INCLUIDAS
PIÈCES INCLUSES

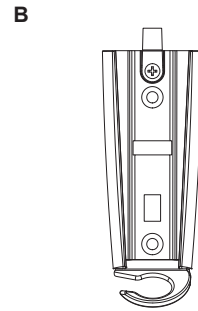
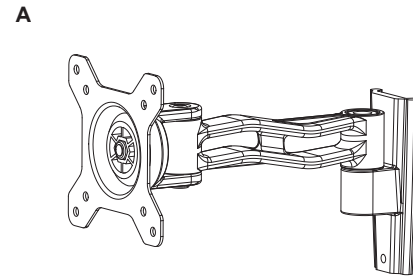

C	M4x12 (x4)	M4x30 (x4)
D	M6x12 (x4)	M6x30 (x4)
E	18X8X20 (x4)	
F	M6x51 (x2)	Ø8x40 (x2)
G	S=3mm (x1)	S=4mm (x1)

► **INSTALLATION / INSTALACIÓN / INSTALAÇÃO / INSTALLATION**

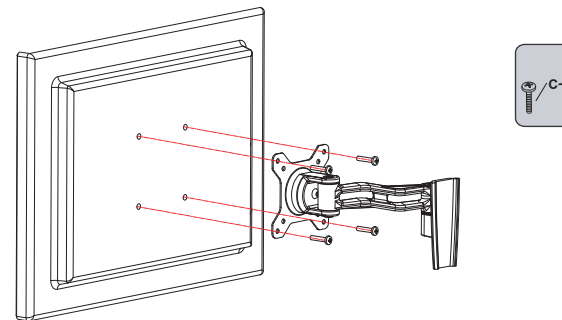
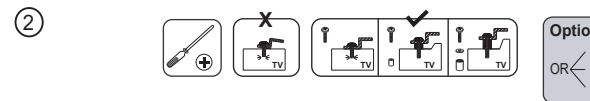
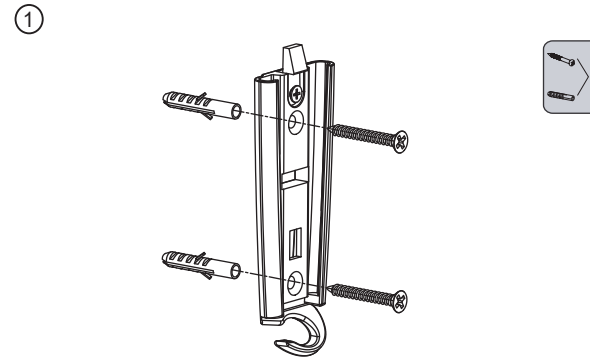

OR

